

गढवळि अक्सर ज्ञान की किताब



अखोड़



आरु



इमलि



परिचय

गढवळि भाषा मा लिखिं य अक्सर ज्ञाने की किताब आप लुखूं का समणि प्रस्तुत करण मा हमतैं भौत ही खुसि होणि च। य किताब छात्रों तैं गढवळि भाषा मा पढन-लिखण सिखाणा का उद्देस्या से बणेयीं च। ई किताब तैं बणाण दौं छात्रों की मानसिक स्थरो कू बिसेस ध्यान रखियूं च।

य किताब गढवळि छात्रों कू भौत जरुरी च, इलै ई किताब तैं बणाण दौं जरुरतैं अनुसार गढवळि समुदाय की चितरों कू इस्तेमाल करियूं च, ताकि छात्रों तै कुछ भी इन नी लगो कि य किताब अज्ञात लगणी च। ई किताब तैं लिखणौं उद्देस्या यू च कि सभी छात्र अपणी मात्रभाषा गढवळि मा पढन-लिखण सीख सक्यां।

हम य उम्मीद करद्यां कि ई किताब से गढवळि भाषा बिकास कु प्रयास हे सकु अर गढवाळ समुदाय का माता-पिता अपणा बच्चों तैं ई किताब तैं सिखणु कु अर इस्तमाल कनु खुणि प्रेरणा दिला।

धन्यवाद

अ



अखोड़



अरसा



अल्मोड़

आ



आरु



आदु

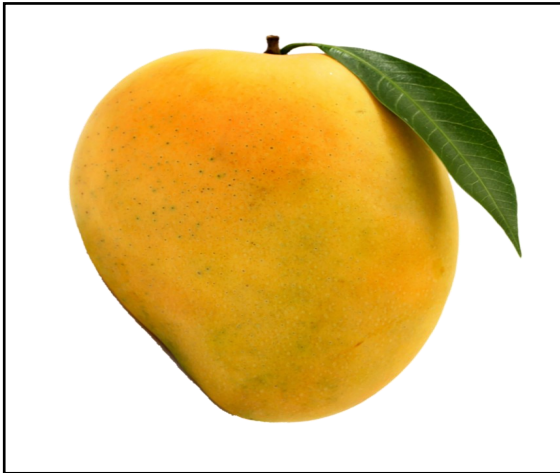

आम

ॐ



इमलि



इलाज



इलडु

उ



उरख्याळु



उड्यार

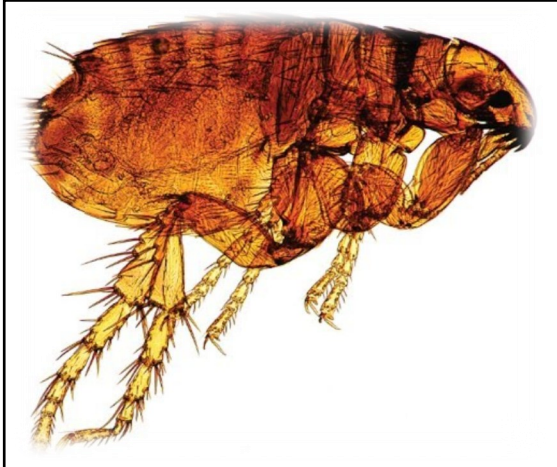

उपन

ऊ



ऊमि



ऊन



ऊट

ऐ



ऐना



ऐत्वाळ



ऐनक

ओ



ओड़ु



ओड़खु



ओदु

औ

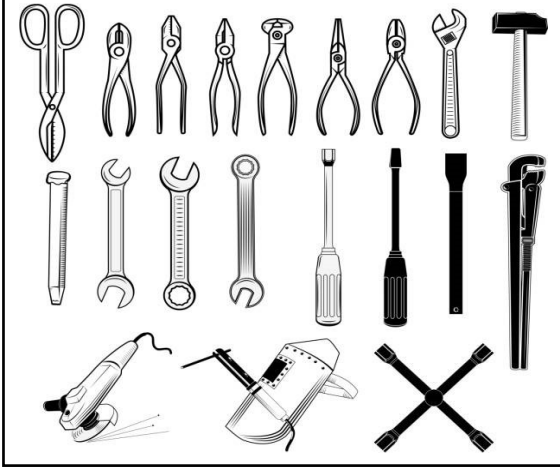

औजार



औत



औरत

क



कन्डा



कव्वा



कमळु

ख

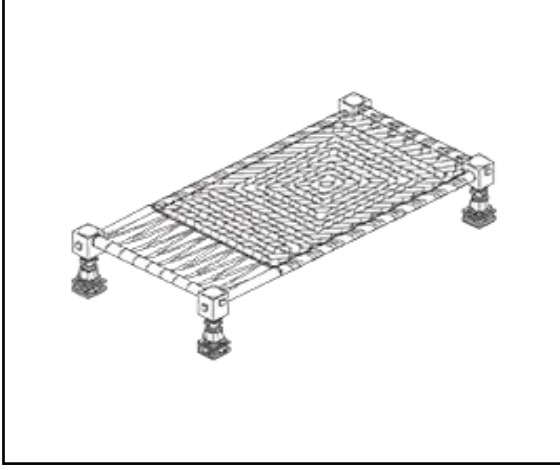

खटलु



खच्चर



खडिक

ग



गदेलि



गरुड



गदेरु

घ



घडोळु



घट



घसेरी

च



चकोर



चलखुड़ा

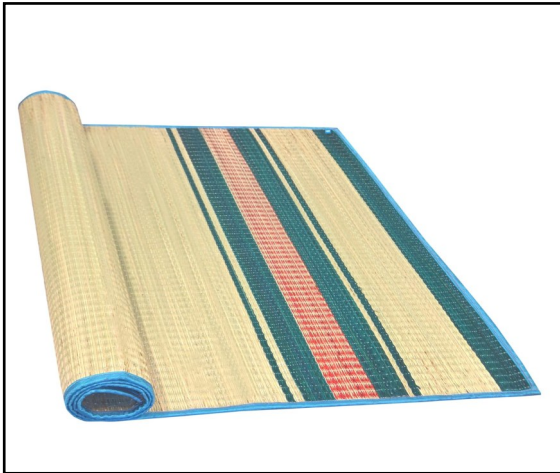

चटै

छ



छन्न



छपला



छतुरु

ज



जरुया



जन्दुरु



जग

झ



झगुली



झंगोरु



झळकीडु

ट



टमोटु



टका

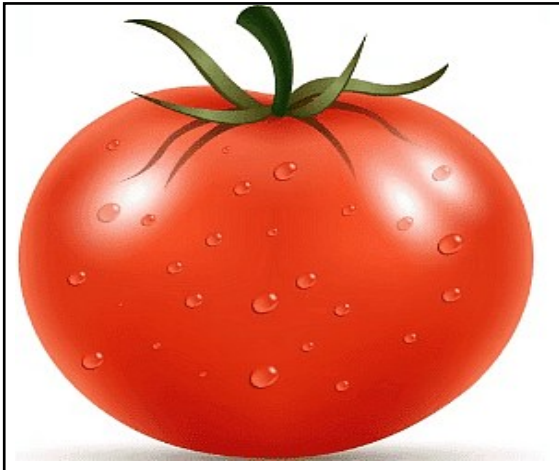

टमाटर

ड



डब्बा



डकखु



डरैबर

ह

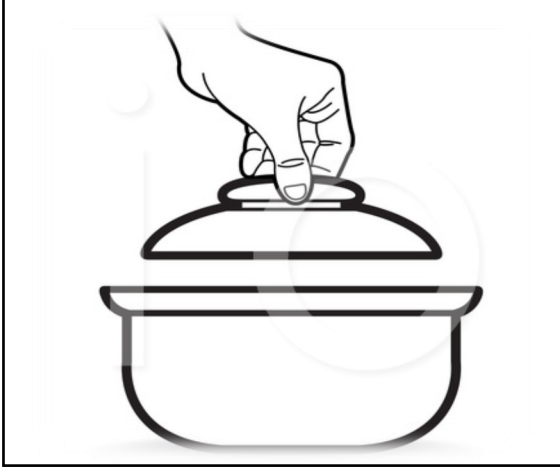

ढक्कण



ढण्डी

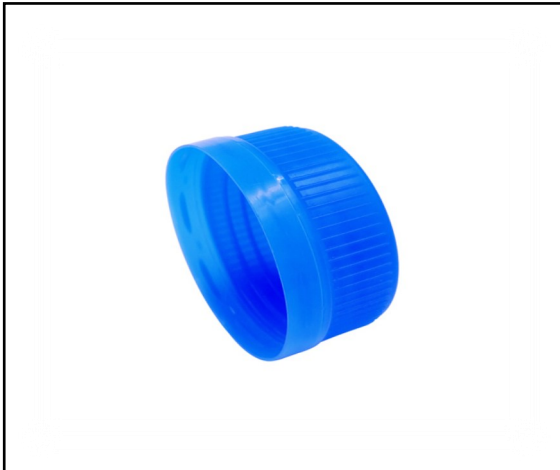

ढक्कण

त



तरजू



तकळु



तस्लु

थ



थकलु



थमळु



थरमस

द



दथड़ो



दमौ



दन्दौळु

ध



धगुली



धण्या



धतुरु

न



नथुलि



नळखा



नरयूळ

प



पन्देरु



पठळा



पत्युड

फ



फरेपान



फडुवा



फरसा

ब



बखरु



बछुरु



बळद

भ



भट्ट



भट्टा



भदळु

म



मकड़ा



मछोई



मल्यो

र



रयांस



रणसिंग



रन्दा

ल



लटुला



लसण



लगलु

स



सट्टी



सरग



सरसु

ह



हळदु



हथौडु

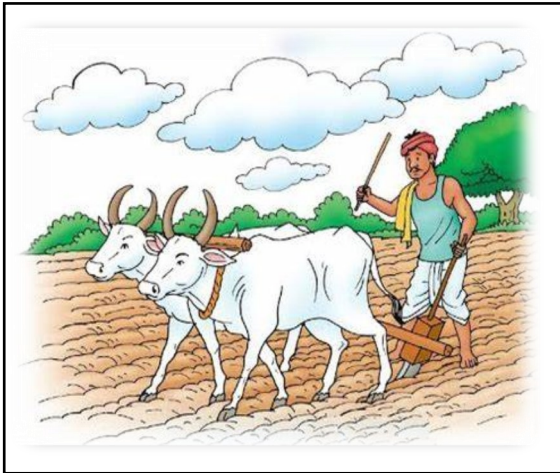

हळया